

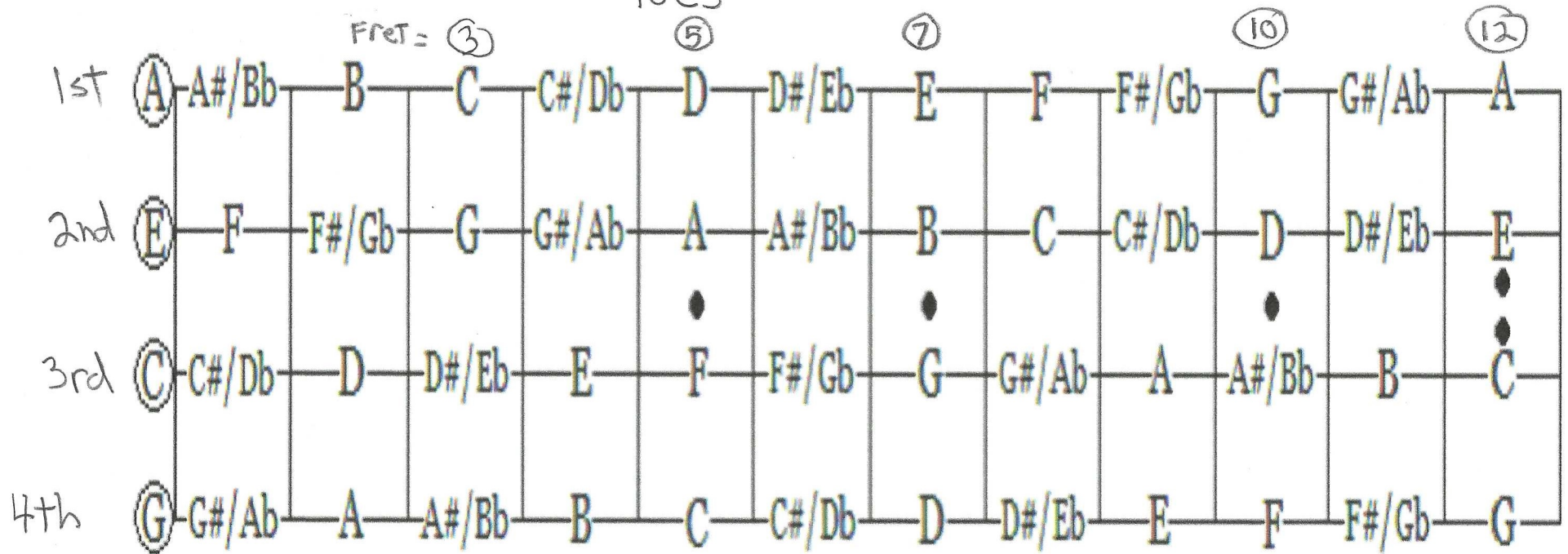

Steve Kritzer Workshop
Playing Chords Up the Neck
Foster City Library, 1/27/24, 2-4pm

Welcome/Introductions
Ukulele Fretboard Map
Alternate Chord Positions
Jambalaya
Lean On Me
Jamaica Farewell
Moveable Chord Progressions
I'm Yours
26 Miles
Memories
Don't Stop Believing

"Toes"



"nose"

Major Scales and Chord Positions
 ("Nashville" Number System)

KEYS

1 _(# keys) **2** **3** **4** **5** **6** **7** **8**
 w w H w w w H
 (*=dim)

C	Dm	Em	F	G	Am	B*	C
G	Am	Bm	C	D	Em	F#*	G
D	Em	F#m	G	A	Bm	C#*	D
A	Bm	C#m	D	E	F#m	G#*	A
E	F#m	G#m	A	B	C#m	D#*	E

(b keys)

F	Gm	Am	Bb	C	Dm	E*	F
Bb	Cm	Dm	Eb	F	Gm	A*	Bb
Eb	Fm	Gm	Ab	Bb	Cm	D*	Eb
Ab	Bbm	Cm	Db	Eb	Fm	G*	Ab

ALTERNATE UKULELE CHORD POSITIONS

(partial - G string optional)

X = don't play

1st position (open)

C C7 D D7 Dm E E7 Em F Fm G G7 Gm A A7 Am Bb B7 Bm

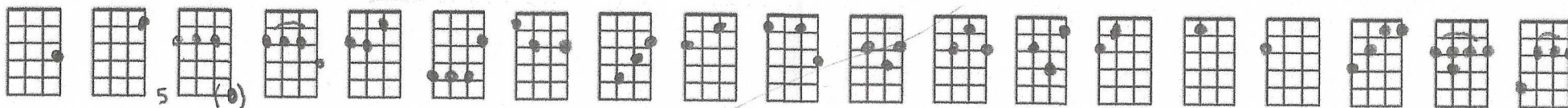

2nd position (3rd-7th fret)

Shapes:

(Bb) (Bb) (B7) (Bm) (D) (D7) (Bm) (D) (Em) (E) (Em) (G) (G7) (Gm) (G) (G7) (Gm) (G)

C C7 D D7 Dm E E7 Em F Fm G G7 Gm A A7 Am Bb B7 Bm

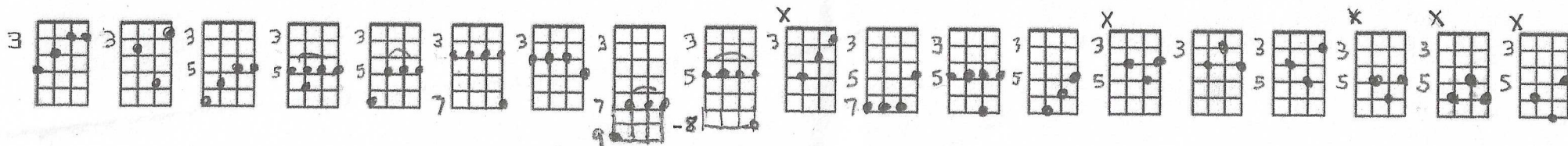

3rd position (7th-12th fret)

Shapes:

(Bb) (G7) (G) (G7) (Gm) (G) (B7) (Gm) (Bb) (Bm) (D) (D7) (Bm) (E) (D7) (Em) (E) (Em)

C C7 D D7 Dm E E7 Em F Fm G G7 Gm A A7 Am Bb B7 Bm

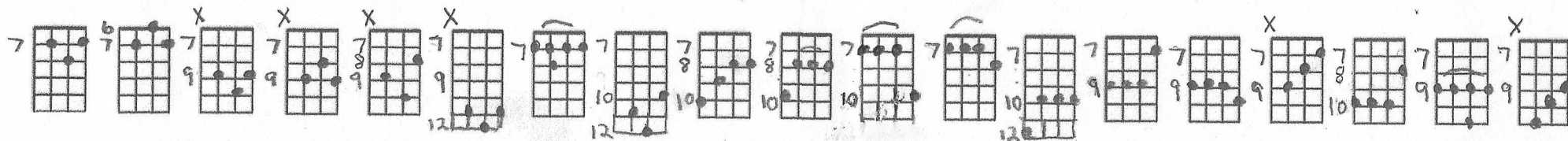

JAMBALAYA

Hank Williams

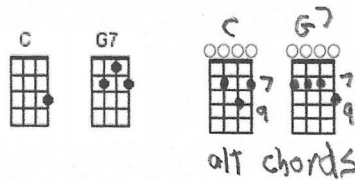

[Verse 1]

C **G7**
Goodbye, Joe, me gotta go, me oh my oh
G7 **C**
Me gotta go pole the pirogue down the bayou
C **G7**
My Yvonne, the sweetest one, me oh my oh
G7 **C**
Son of a gun, gonna have big fun on the bayou

[Chorus]

C **G7**
Jambalaya and a crawfish pie and filé gumbo
G7 **C**
'Cause tonight I'm gonna see my ma chers amio
C **G7**
Pick guitar, fill fruit jar and be gay-o
G7 **C**
Son of a gun, gonna have big fun on the bayou

[Verse 2]

C **G7**
Thibodaux, Fontaineaux, the place is buzzin'
G7 **C**
kinfolk come to see Yvonne by the dozen
C **G7**
Dress in style and go hog wild, and be gay-o
G7 **C**
Son of a gun, gonna have big fun on the bayou

(CHORUS)

[Verse 3]

C **G7**
Later on, swap my mon, get me a pirogue
G7 **C**
And I'll catch all the fish on the bayou
C **G7**
Swap my mon, to buy Yvonne what she need-oh
G7 **C**
Son of a gun we'll have big fun on the bayou

(CHORUS)

LEAN ON ME (w alt chords)

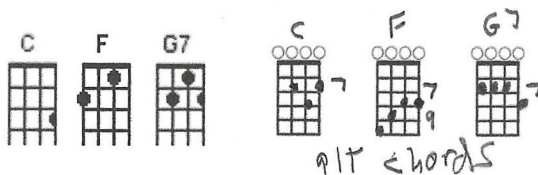

[Verse 1]

C F C G7
 Sometimes in our lives, we all have pain We all have sorrow
 C F C | G7 C |
 But if we are wise we know that there's always tomor-row

[Chorus]

C F
 Lean on me, when you're not strong,
 C G7
 And I'll be your friend, I'll help you carry on
 C F C | G7 C |
 For it won't be long 'Til I'm gonna need somebody to lean on

[Verse 2]

C F C G7
 Please swallow your pride If I have things you need to borrow
 C F C | G7 C |
 For no one can fill those of your needs that you don't let show

[Bridge]

C (stop)
 So just call on me brother, when you need a hand
 C | G7 C |
 We all need somebody to lean on
 C (stop)
 I just might have a problem that you'd understand
 C | G7 C |
 We all need somebody to lean on

[Chorus]

C F
 Lean on me, when you're not strong,
 C G7
 And I'll be your friend, I'll help you carry on
 C F C | G7 C |
 For it won't be long 'Til I'm gonna need somebody to lean on

(BRIDGE)

(CHORUS)

JAMAICA FAREWELL

(with moveable chords)

Key of C

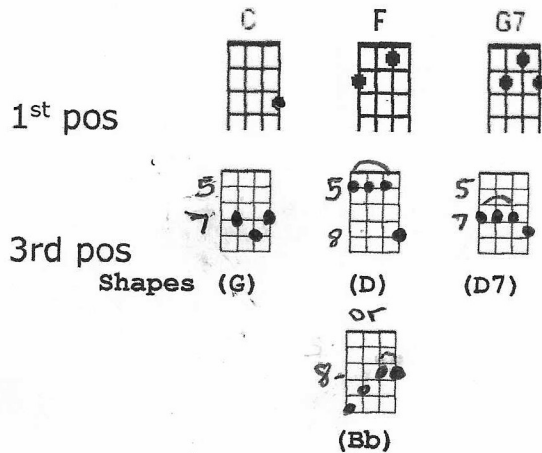

Verse 1:

C F
Down the way where the nights are gay, and the
G7 C
Sun shines daily on the mountain top
C F
I took a trip on a sailing ship, and when I
G7 C
Reached Jamaica, I made a stop, now I'm

Chorus:

C F
Sad to say, I'm on my way
G7 C
won't be back for many a day
C F
My heart is down, my head is turning around, I got to
G7 C
Leave a little girl in Kingston Town

Verse 2:

C F
Sounds of laughter everywhere, and the
G7 C
Dancing girls sway to and fro
C F
I must declare that my heart is there, though I've
G7 C
Been from Maine to Mexico, now I'm

(CHORUS)

Verse 3:

C F
Down at the market you can hear, ladies
G7 C
Cry out while on their heads they bear
C F
Akii rice and salt fish are nice
G7 C
And the rum is fine anytime of year, now I'm

(CHORUS) 2X

TYPICAL MOVEABLE CHORD PROGRESSIONS

1 (6m) 4 5 progression

KEY OF C

C (Am) F G7

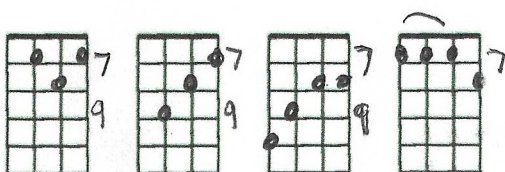
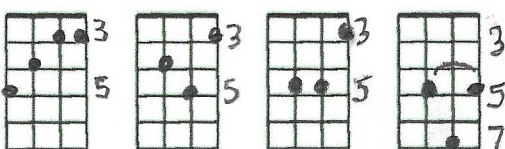
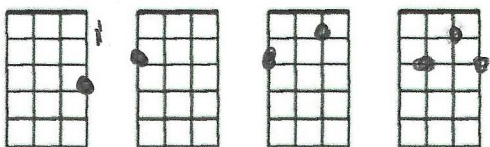

KEY OF G

G (Em) C D7

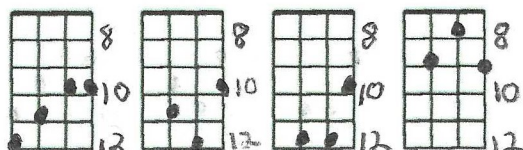
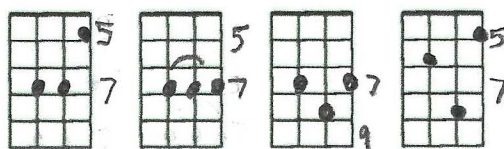
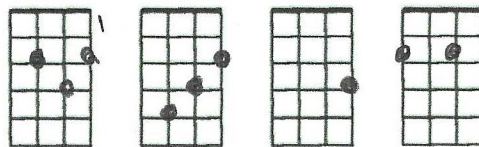

KEY OF D

D (Bm) G A7

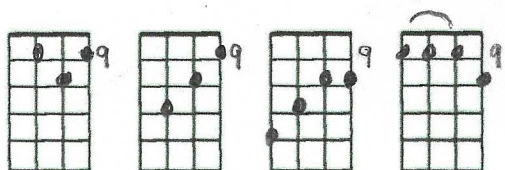
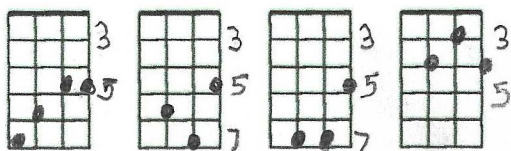
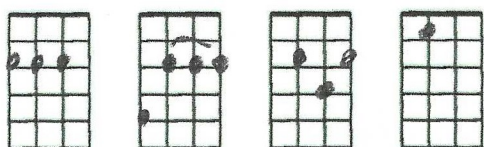

KEY OF F

F (Dm) Bb C7

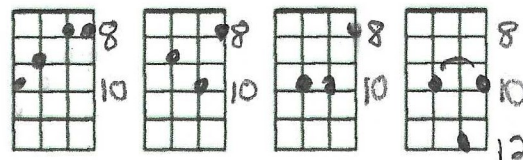
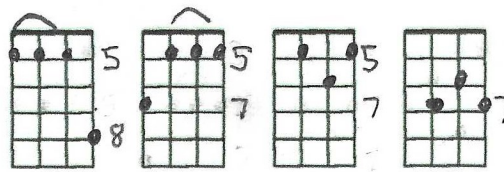
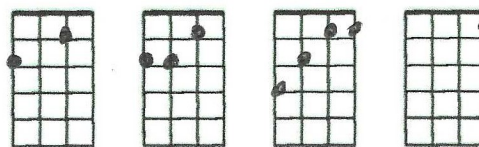

1st position

2nd position

3rd position

1st position

2nd position

3rd position

I'M YOURS Jason Mraz

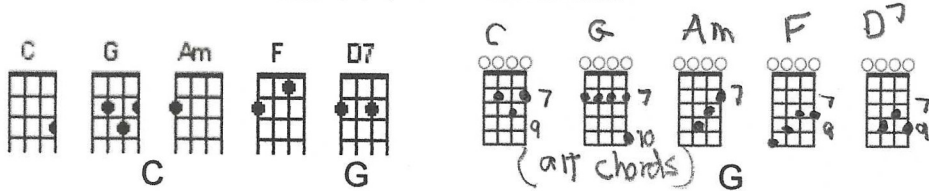

C G Am F D7 C G Am F D7
 You done done me, and you bet I felt it, I tried to be chill, but you're so hot that I melted
 Am Am F F
 I fell right through the cracks, And now I'm trying to get back, before the
 C C G G
 Cool done run out I'll be givin' it my bestest,, nothing's gonna stop me but divine intervention
 Am Am F F
 I reckon it's again my turn, To win some or learn some

[Chorus]

C C G G Am Am F F
 But I won't hesi- tate No more, no more It cannot wait I'm yours

[Verse]

C C G G
 Open up you mind and see like me, Open up your plans and then you're
 Am Am F F
 free, Look into your heart and you'll find Love, love, love
 C C G G
 Listen to the music of the moment people dance and sing, We're just one big family
 Am Am F F D7 D7
 And it's our godforsaken right to be Loved, loved, loved, loved, loved

[Chorus]

C C G G Am Am F F
 But I won't hesi- tate No more, no more It cannot wait I'm sure, there's no
 C C G G Am Am F F
 Need to compli- cate our time is short, this is our fate, I'm yours, been spending

[Verse]

C C G G
 Way too long checking my tongue in the mirror, bending over backwards try to see it clearer
 Am Am F F
 My breath fogged up the glass, so I drew a new face and I laughed
 C C G G
 I guess what I be saying is there ain't no better reason, to rid yourself of vanity go with the seasons
 Am Am F F
 It's what we aim to do, Our name is our virtue

[Chorus]

C C G G Am Am F F
 But I won't hesi- tate No more, no more It cannot wait I'm sure, there's no
 C C G G Am Am F F D7
 There's no need to compli- cate, our time is short, this is our fate, I'm you- rs,

26 MILES

	C	Am	Dm	G7
1st pos				
2nd pos				
	(Bb)	(Gm)	(Em)	(E7)
3rd pos				
	(G)	(Em)	(Gm)	(D7)

	F	C7	D7
	(E)	(Bb7)	(Bb7) (Shapes)
	(Bb)	(G7)	(G7) (Shapes)

[Verse 1]

C Am Dm G7
 Twenty-six miles across the sea
 C Am Dm G7
 Santa Catalina is a-waitin' for me,
 C Am Dm G7
 Santa Catalina, the island of romance,
 C Am Dm G7
 romance, romance, romance, romance.

[Verse 2]

C Am Dm G7
 Water all a-round it ev'rywhere,
 C Am Dm G7
 tropical trees and the salty air,
 C Am Dm G7
 but for me the thing that's a-waitin' there's romance.

[Bridge]

Dm G7 C Am
 It seems so distant, twenty-six miles away,
 Dm G7 C Am
 restin' in the water serene.
 Dm G7 C Am
 Think I'd work for anyone, even the Navy,
 D7 G7 G7
 who would float me to my island dream.

[Verse 3]

C Am Dm G7
 Twenty-six miles across the sea
 C Am Dm G7
 Santa Catalina is a-waitin' for me,
 C Am Dm G7
 Santa Catalina, the island of
 C Am Dm G7 C
 romance, romance, romance, romance

MEMORIES Maroon 5

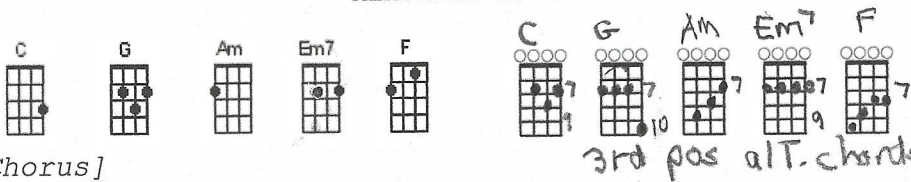

[Intro/ Chorus]

C **G**
 Here's to the ones that we got
Am **Em**
 Cheers to the wish you were here but you're not
F **C**
 'Cause the drinks bring back all the memories
F **G**
 Of everything we've been through

C **G**
 Toast to the ones here today
Am **Em**
 Toast to the ones that we lost on the way
F **C**
 'Cause the drinks bring back all the memories
F **G** N.C.
 And the memories bring back memories, bring back you

[Verse 1]

C **G** **Am** **Em**
 There's a time that I remember, when I did not know no pain
F **C** **F** **G**
 When I believed in forever, and everything would stay the same
C **G** **Am** **Em**
 Now my heart feel like December, when somebody say your name
F **C** **F** **G**
 'Cause I can't reach out to call you, but I know I will one day, ayy

[Pre-Chorus 1]

C **G** **Am** **Em**
 Everybody hurts sometimes, everybody hurts someday, ayy-ayy
F **C** **F** **G**
 But everything gon' be alright, go and raise a glass and say, ayy

(CHORUS)

[Verse 2]

C **G** **Am** **Em**
 There's a time that I remember, when I never felt so lost
F **C** **F** **G**
 When I felt all of the hatred, was too powerful to stop (oooh yeah)
C **G** **Am** **Em**
 Now my heart feel like an ember, and it's lighting up the dark
F **C** **F** **G**
 I'll carry these torches for ya, and you know I never drop, yeah

[Pre-Chorus 2]

C **G** **Am** **Em**
 Everybody hurts sometimes, everybody hurts someday, ayy-ayy
F **C** **F** **G**
 Everything gon' be alright, go and raise a glass and say, ayy

(CHORUS)

DON'T STOP BELIEVING Steve Perry/ Neil Schoen

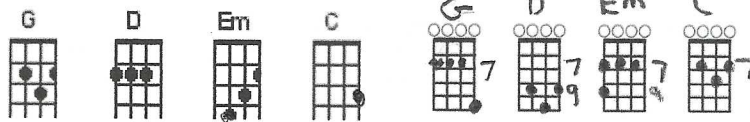

ALT. Chords

[Intro] G D Em C G D Em C

Verse 1

G D Em C
 Just a small town girl, Livin' in a lonely world
 G D Em C
 She took the midnight train goin' any-where
 G D Em C
 Just a city boy, Born and raised in south Detroit
 G D Em C
 He took the midnight train goin' any-where

Verse 2

G D Em C
 A singer in a smoky room, A smell of wine and cheap perfume
 G D Em C
 For a smile they can share the night, It goes on and on and on and on

[Chorus]

C C G G
 Strangers waiting Up and down the boulevard, their
 C C G G
 Shadows searching in the night
 C C G G
 Streetlight people Living just to find emotion
 C C D D
 Hiding somewhere in the night

Verse 3

G D Em C
 Working hard to get my fill, Everybody wants a thrill
 G D Em C
 Payin' anything to roll the dice just one more time
 G D Em C
 Some will win, some will lose, Some were born to sing the blues
 G D Em C
 Oh, the movie never ends, it goes On and on and on and on

[Chorus]

C C G G
 Strangers waiting Up and down the boulevard, their
 C C G G
 Shadows searching in the night
 C C G G
 Streetlight people Living just to find emotion
 C C D D
 Hiding somewhere in the night

Solo: G D Em C G D Em C

[Last Chorus]

G D Em C
 Don't stop believing, hold on to that feeling
 G D Em C
 Streetlight people, whoa oh
 G D Em C
 Don't stop believing, hold on to that feeling
 G D Em C G
 Streetlight people, whoa oh